

Kidde Fire Systems HPCO2 Component Description



Nameplate—Signs, CO2
P/N: 06-231866-85X

Effective: April 2022
K-81-9171 Rev AB

FEATURES

- Complies with MNB/ANSI 2535, Standard for Environmental and Facility Safety Signs

DESCRIPTION

NFPA 12, the *Standard on Carbon Dioxide Extinguishing Systems*, requires the use of warning signs in conspicuous locations surrounding areas protected by CO2 Fire Suppression Systems. Each hazardous location has its own dedicated signage, as shown below. (See the reverse side for ordering information.)

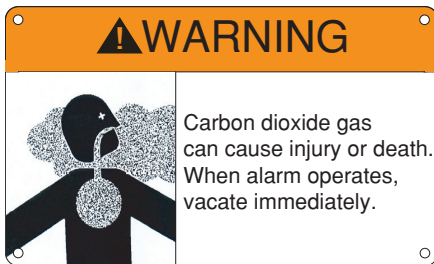

Figure 1. Sign in Every Protected Space

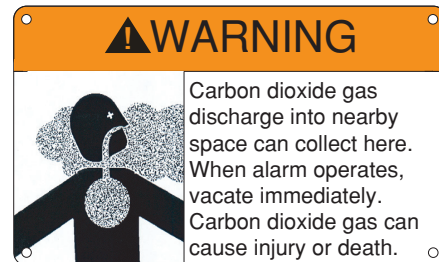

Figure 4. Sign in Every Nearby Space Where Carbon Dioxide Can Accumulate to Hazardous Levels

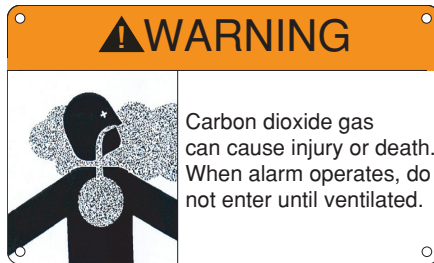

Figure 2. Sign at Every Entrance to Protected Space

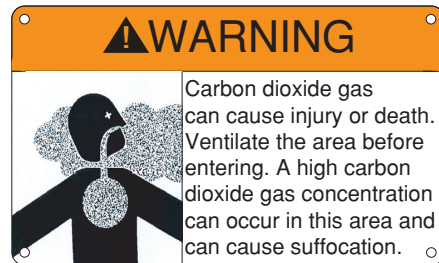

Figure 5. Sign Outside Each Entrance to Carbon Dioxide Storage Rooms

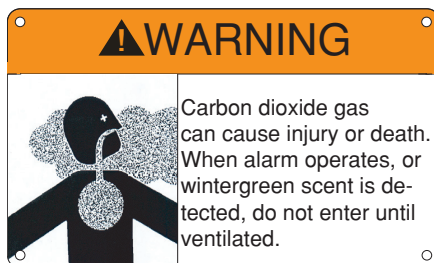

Figure 3. Sign at Every Entrance to Protected Space for Systems Provided with a Wintergreen Odorizer

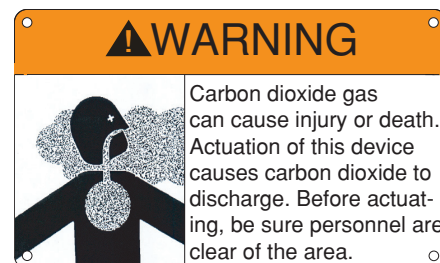

Figure 6. Sign at Each Manual Actuation Station

SPECIFICATIONS:

- Material: Aluminum, .032 thick.
- Size: See Figure 7.
- Finish: A clear plastic peelable cover for protection of the printed side.
- Colors: Tri-Color: white background; orange Warning background; black characters.

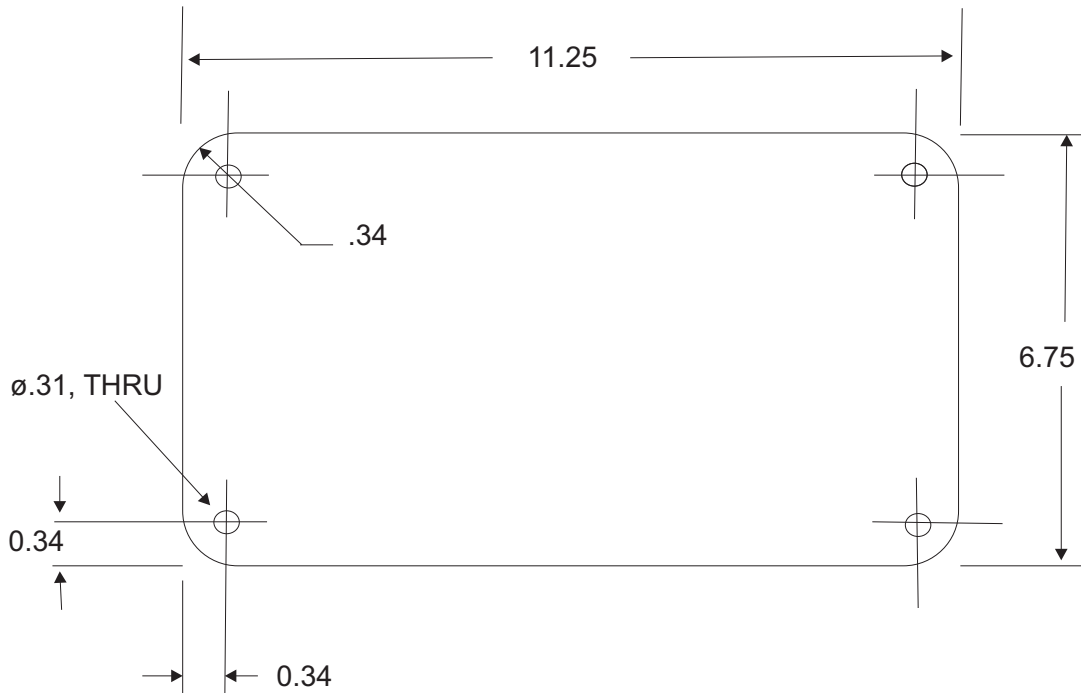

Figure 7. Sign Dimensions

ORDERING INFORMATION

Part Number	Description	Figure Reference
06-231866-851	Vacate	Figure 1
06-231866-852	Do Not Enter	Figure 2
06-231866-853	Odorizer	Figure 3
06-231866-854	Migration	Figure 4
06-231866-855	Storage	Figure 5
06-231866-856	Actuation	Figure 6

EXPORT INFORMATION (USA)

Jurisdiction: EAR
 Classification: EAR99

This document contains technical data subject to the EAR.

All trademarks are the property of their respective owners.

This literature is provided for informational purposes only. KIDDE-FENWAL, INC. believes this data to be accurate, but it is published and presented without any guarantee or warranty whatsoever. KIDDE-FENWAL, INC. assumes no responsibility for the product's suitability for a particular application. The fire suppression system design, installation, maintenance, service and troubleshooting must be performed by trained, authorized Kidde Fire Systems distributors for the product to work correctly. If you need more information on this product, or if you have a particular problem or question, contact: KIDDE-FENWAL, INC., Ashland, MA 01721 USA, Telephone: (508) 881-2000.